

UDUPI COCHIN SHIPYARD LIMITED

(Formerly Tebma Shipyards Limited)



Date: 12.09.2024

TENDER ENQUIRY

Dear Sirs,

Sealed Tenders in duplicate, super scribing the Enquiry Number & Last date for receipt of Quotations on the envelope, are invited **TWO BID SYSTEM** two separate covers as 'Part- I Techno-commercial' and 'Part- II Price' - both enclosed in the single envelope, for the supply of following materials to reach the undersigned on or before the last date and time shown. Tenders should be addressed to **Assistant General Manager (Materials), Udupi Cochin Shipyard Limited, Malpe Harbor Complex, Malpe. Udupi-576108, Karnataka, India.**

Submission by Email: Offers (both Part- I Techno-commercial' and 'Part- II Price) in two separate password protected PDF file format, can also be made by E-mail (sony.clement@udupicsl.com, sunilsnair@udupicsl.com / purchase@udupicsl.com / muhammad.anas@udupicsl.com / midhunthomas@udupicsl.com) on or before, the last date & time of receipt of tender as shown below, if delivery of sealed offers cannot be ensured at UCSL on the due date. The offer PDF files (Part- I Techno-commercial' and 'Part- II Price) to be named clearly (**UCSL/MAT/PROJ/2024-25/1256- Techno-commercial and UCSL/MAT/PROJ/2024-25/1256- Price bid**)

Enquiry No.	Enquiry Date	Last Dt. & Time for Receipt of Tender	Tender Opening Date & Time
UCSL/MAT/PROJ/2024-25/1256	12.09.2024	27.09.2024, 15:30:00	27.09.2024, 15:30:00

Sl No	Material Code	Material/ Service Description	UOM	Qty	Yard No	Required Date at UCSL
1		Tire Fenders-Anchor Sshackle & Sling	Shipset	04	UCSL Y171 to Y174	As per document

In case of any commercial queries, please contact: Mr. Sony Clement - AGM (Materials), Muhammad Anas - Manager (Materials) Mobile No. 8129443366, Sunil Sasidharan Nair - Manager (Materials) Mobile No. 9884917724, Midhun Thomas - Assistant Manager (Materials) Mobile No. 9995777763, Email: sony.clement@udupicsl.com, muhammad.anas@udupicsl.com, midhunthomas@udupicsl.com, purchase@udupicsl.com, purchase1@udupicsl.com, sunilsnair@udupicsl.com
For Technical queries please contact: Email: sarun.kumar@udupicsl.com

उडुपी कोचीन शिपयार्ड लिमिटेड
पन्नन, पोत परिवहन और जलमार्ग मंत्रालय
भारत सरकार

UDUPI COCHIN SHIPYARD LIMITED
Ministry of Ports, Shipping & Waterways
Government of India

पंजीकृत कार्यालय:
एस. नं. 377, पशामतूर गांव
पुकातुरई पोस्ट, मदुरान्तक तालुका
कांचीपुरम - 603 116, तमिल नाडु, भारत।
कॉर्पोरेट कार्यालय:
माल्पे हार्बर कॉम्प्लेक्स, माल्पे
उडुपी - 576 108, कर्नाटक, भारत।

Registered Office:
S.No.377, Pazhamathur Village
Pukathurai Post, Madurantakam Taluk
Kancheepuram - 603 116, Tamil Nadu, India
Corporate Office:
Malpe Harbour Complex, Malpe
Udupi - 576 108 Karnataka India

Phone:
+91 820 2538600
Fax :
+91 820 2538605

www.tebma.co.in

Enclosures:

1. Purchase Technical Specifications- Annexure 1
2. General Terms and Conditions of procurement - Annexure 2
3. Price bid format - Annexure 3
4. Bank Guarantee/Security Deposit Format - Annexure 4

For Udupi Cochin Shipyard Ltd,



Authorized Signatory

Sony Clement T M
Authorized Signatory

PRICE BID FORMAT

Tender Enquiry No: UCSSL/MAT/PROJ/2024-25/1256

Tender Enquiry Date:12 September 2024

Vessel/Project: Y 171-Y174

SL. NO	DESCRIPTION	Quantity	UOM	Currency	Unit Rate	Total Price
1	HEAVY DUTY AIRCRAFT TYRES 865MM DIA	72	EA			
2	ANCHOR SHACKLE	288	EA			
3	SLING SWF - 3T	288	EA			
	TOTAL BASIC PRICE FOR 4 SHIPSETS					
4	Packing & Forwarding Charges / FOB Charges	4	Shipset			
5	Freight Charges	4	Shipset			
7	Other Charges, if any (specify)	4	Shipset			
8	Transit Insurance and Unloading Charges	By UCSSL				
9	GST (as applicable)					
10	HSN CODE					
11	Total Order value for 4 Ship sets					
12	Delivery Period required at UCSSL stores		1st Shipset-Within 3 month from the date of PO 2nd Shipset- Within 5 month from the date of PO 3rd and 4th Shipset- Within 7 month from the date of PO			

Signature :

Name & Address of the firm

Important Note:



- Un-priced Bid, to be submitted along with techno commercial bid with details like percentage of taxes & duties applicable and showing whether "Amount quoted/ Nil/ Included/ By UCSSL" against respective column. Confirmation regarding exercising the option shall be provided during finalization of the purchase order.
- The prices quoted in column no 1 to 7 above will be added and the bidder who has quoted the aggregate lowest will be declared the Lowest bidder (Overall L1 bidder) and hence Individual Line item Lowest will not be considered for order placement.

Rev.	Pages	Description	Date	Sign.
0	02	First Issue	20-05-2024	Chaturanan

70 T BOLLARD PULL ASD TUG

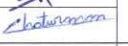

UDUPI COCHIN SHIPYARD LTD
(A Cochin Shipyard Company)

YARD NO	UY173	70 T BOLLARD PULL ASD TUG	
OWNER	POLESTAR MARITIME	PURCHASE TECHNICAL SPECIFICATIONS FOR SUPPLY OF TIRE FENDERS, ANCHOR SHACKLE AND SLING	
APPROVED	AJITH KUMAR T 		
CHECKED	SARVESH G BHAT 		
PREPARED	CHATURANAN 		
DATE	20-05-2024	Doc. No.: PTS-173-025	Rev. No: 0
ISSUED TO	NO. DEP.		

This document/specification is the property of Udupi Cochin Shipyard Limited, and it must not be copied or the contents thereof or any information received in conjunction therewith must not be imparted /shared to any third party or utilized for any other purpose. The receipt of the document/specification implies that the conditions as mentioned herein are accepted.



UDUPI COCHIN SHIPYARD LTD
(A COCHIN SHIPYARD COMPANY)
MALPE – 576108 INDIA

70 T BOLLARD PULL ASD
TUG

TIRE FENDERS

Yard No.

Doc. No

Rev. No

Page No.

UY173

PTS-173-025

0

2

**TECHNICAL SPECIFICATION FOR SUPPLY OF
TIRE FENDERS, ANCHOR SHACKLE AND SLING**

1. SCOPE OF SUPPLY

This specification relates to the supply of **Tire Fenders, Anchor Shackle and Sling** for the 70T Bollard Pull ASD Tug being built at Udupi Cochin Shipyard Ltd. Quantity shall be as per the table at SI No. 2.

2. QUANTITY REQUIREMENT TABLE

The below mentioned is for 1 vessel.

SL No	Tyre Type	Qty. (Nos.)	Remarks
1	Heavy Duty Aircraft Tires (Ø865mm)	18 Nos.	Drawings Attached
2	19.1mm SS Anchor Shackle with SS bolt, Nut & Pin	72 Nos.	Drawings Attached
3	Sling SWF: 3T minimum	4 Nos. each tire (Heavy-Duty Aircraft Tires)	Drawings Attached

Drawings attached – Sample Guidance drawing for reference.

Tire Fenders offered by the supplier may be submitted with drawings for Evaluation & Subject to yard/owner approval.

Sling shall be provided as mentioned above in table with reference to D-shackle compatibility.

3. CONDITIONS OF SUPPLY

- 3.1 The items shall be manufactured from best quality material and workmanship and to be supplied. The supply shall be as per the attached sample drawings and deviations if any shall be clearly indicated in the offer.
- 3.2 The Tire Fenders, Anchor Shackle and Sling shall be unexploited and shall be of good quality suited for 70 T bollard pull operation. Also, the items shall be equipped for efficient and proper working under worst marine conditions.
- 3.3 Anything necessary to accomplish this must be supplied notwithstanding any omission in the specification.

4. TESTING AND INSPECTION

Manufacturer's shop test and inspection shall be carried out in accordance with the manufacturer's standard and certificates shall be submitted.

5. GUARANTEE

As per the commercial terms and conditions of this tender enquiry.

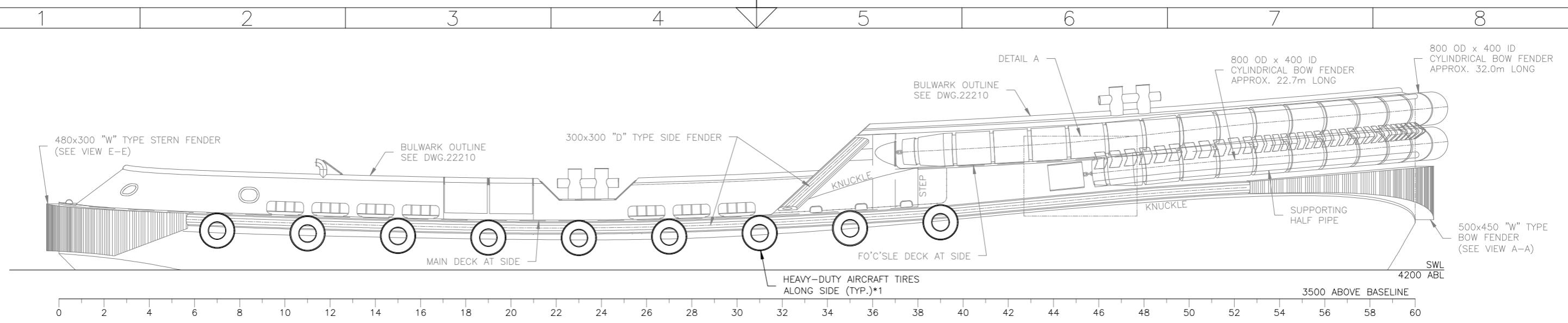

OUTBOARD PROFILE
STARBOARD SIDE SHOWN, LOOKING TO PORT
PORT SIDE SIMILAR

*1 34x10.75 (Ø864 OD) TIRES SHOWN FOR REFERENCE.
ADJUST TO SUIT SELECTED TIRE. VERIFY LOCATION
TO SUIT OWNER PREFERENCE.

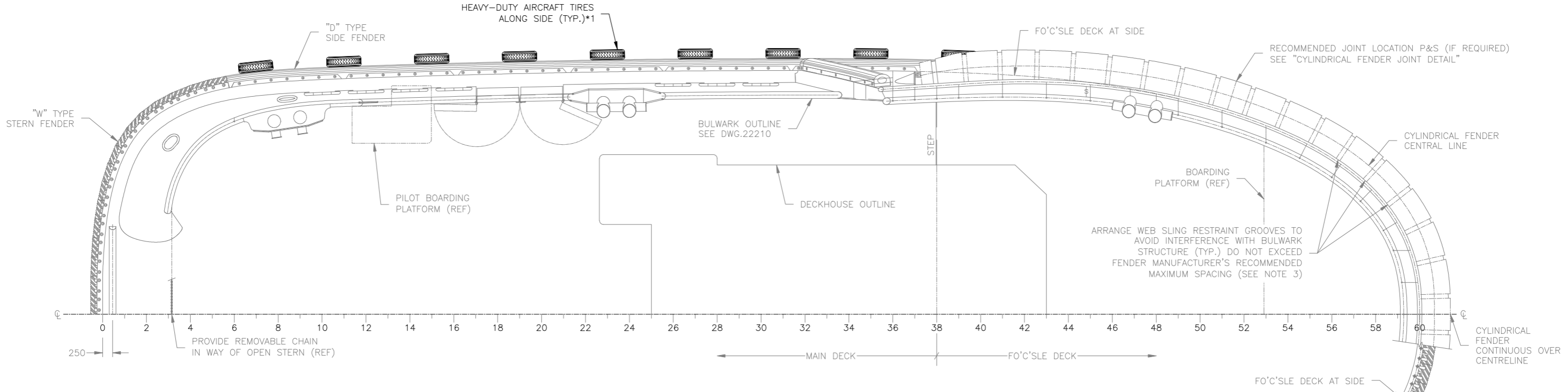

DECK PLAN
PORT SIDE SHOWN, STARBOARD SIDE SIMILAR

UDUPI COCHIN SHIPYARD LTD.
Corporate Office: Malpe Harbour Complex, Malpe, Udupi-576 108, Karnataka, India.
Phone:+91 820 2508 100, Fax:+91 820 2508 105, email : info.tsl@udupicsl.com
website: www.udupicsl.com

CLIENT
OCEAN SPARKLE LTD.

DESIGNER
UDUPI COCHIN SHIPYARD LTD.

DRAWING NO.
173 - 535 - 004

All Dimensions are in mm

0	20-05-2024	INITIAL ISSUE	CHA	SGB	AKT
REV	DATE	DESCRIPTION	PREPARED	CHECKED	APPROVED
TITLE TIRE FENDER ARRANGEMENT					
SCALE	FORMAT	PROJECT	FILE Gr.No.	REVISION	PAGE No.
1:100	A3	UY 173	3.4	0	01 OF 02

THIS DRAWING/SPECIFICATION IS THE PROPERTY OF UDUPI COCHIN SHIPYARD LTD, AND MUST NOT BE COPIED OR THE CONTENTS THERE OF OR ANY INFORMATION RECEIVED IN CONJUNCTION THERE WITH MUST NOT BE IMPORTED TO ANY UNAUTHORIZED THIRD PARTY. THE RECEIPT OF THE DRAWING/SPECIFICATION IMPLIES THAT THE CONDITIONS MENTIONED HERE IN ARE ACCEPTED.

Rev.	Pages	Description	Date	Sign.
0	02	First Issue	24-06-2024	Chaturanan

70 T BOLLARD PULL ASD TUG



UDUPI COCHIN SHIPYARD LTD
(A Cochin Shipyard Company)

YARD NO	UY171, 172 & 174	70 T BOLLARD PULL ASD TUG																		
OWNER	OCEAN SPARKLE LTD.	PURCHASE TECHNICAL SPECIFICATIONS FOR SUPPLY OF TIRE FENDERS, ANCHOR SHACKLE AND SLING																		
APPROVED	AJITH KUMAR T <i>[Signature]</i>																			
CHECKED	SARUN S KUMAR <i>[Signature]</i>																			
PREPARED	CHATURANAN <i>[Signature]</i>																			
DATE	24-06-2024	Doc. No.: PTS-171-025	Rev. No: 0																	
ISSUED TO	NO. DEP.																			
	NO.																			

This document/specification is the property of Udupi Cochin Shipyard Limited, and it must not be copied or the contents thereof or any information received in conjunction therewith must not be imparted /shared to any third party or utilized for any other purpose. The receipt of the document/specification implies that the conditions as mentioned herein are accepted.



UDUPI COCHIN SHIPYARD LTD
(A COCHIN SHIPYARD COMPANY)
MALPE – 576108 INDIA

70 T BOLLARD PULL ASD TUG

TIRE FENDERS

Yard No.

Doc. No

Rev. No

Page No.

UY171, 172 & 174

PTS-171-025

0

2

**TECHNICAL SPECIFICATION FOR SUPPLY OF
TIRE FENDERS, ANCHOR SHACKLE AND SLING**

1. SCOPE OF SUPPLY

This specification relates to the supply of **Tire Fenders, Anchor Shackle and Sling** for the 70T Bollard Pull ASD Tug being built at Udupi Cochin Shipyard Ltd. Quantity shall be as per the table at SI No. 2.

2. QUANTITY REQUIREMENT TABLE

The quantity indicated below is for only One (01) vessel. **The total requirement is for Three (03) vessels.**

SL No	Tyre Type	Qty. (Nos.)	Remarks
1	Used Heavy Duty Aircraft Tires (Ø865mm)	18 Nos.	Drawings Attached
2	19.1 mm SS Anchor Shackle with SS bolt, Nut & Pin	72 Nos.	Drawings Attached
3	Sling SWF: 3T minimum	4 Nos. each tire (Heavy-Duty Aircraft Tires)	Drawings Attached

Drawings attached – Sample Guidance drawing for reference.

Tire Fenders offered by the supplier may be submitted with drawings for Evaluation & Subject to yard/owner approval.

Sling shall be provided as mentioned above in table with reference to D-shackle compatibility.

3. CONDITIONS OF SUPPLY

3.1 The items shall be manufactured from best quality material and workmanship and to be supplied. The supply shall be as per the attached sample drawings and deviations if any shall be clearly indicated in the offer.

3.2 The Tire Fenders, Anchor Shackle and Sling shall be unexploited and shall be of good quality suited for 70 T bollard pull operation. Also, the items shall be equipped for efficient and proper working under worst marine conditions.

3.3 Anything necessary to accomplish this must be supplied notwithstanding any omission in the specification.

4. TESTING AND INSPECTION

Manufacturer's shop test and inspection shall be carried out in accordance with the manufacturer's standard and certificates shall be submitted.

5. GUARANTEE

As per the commercial terms and conditions of this tender enquiry.

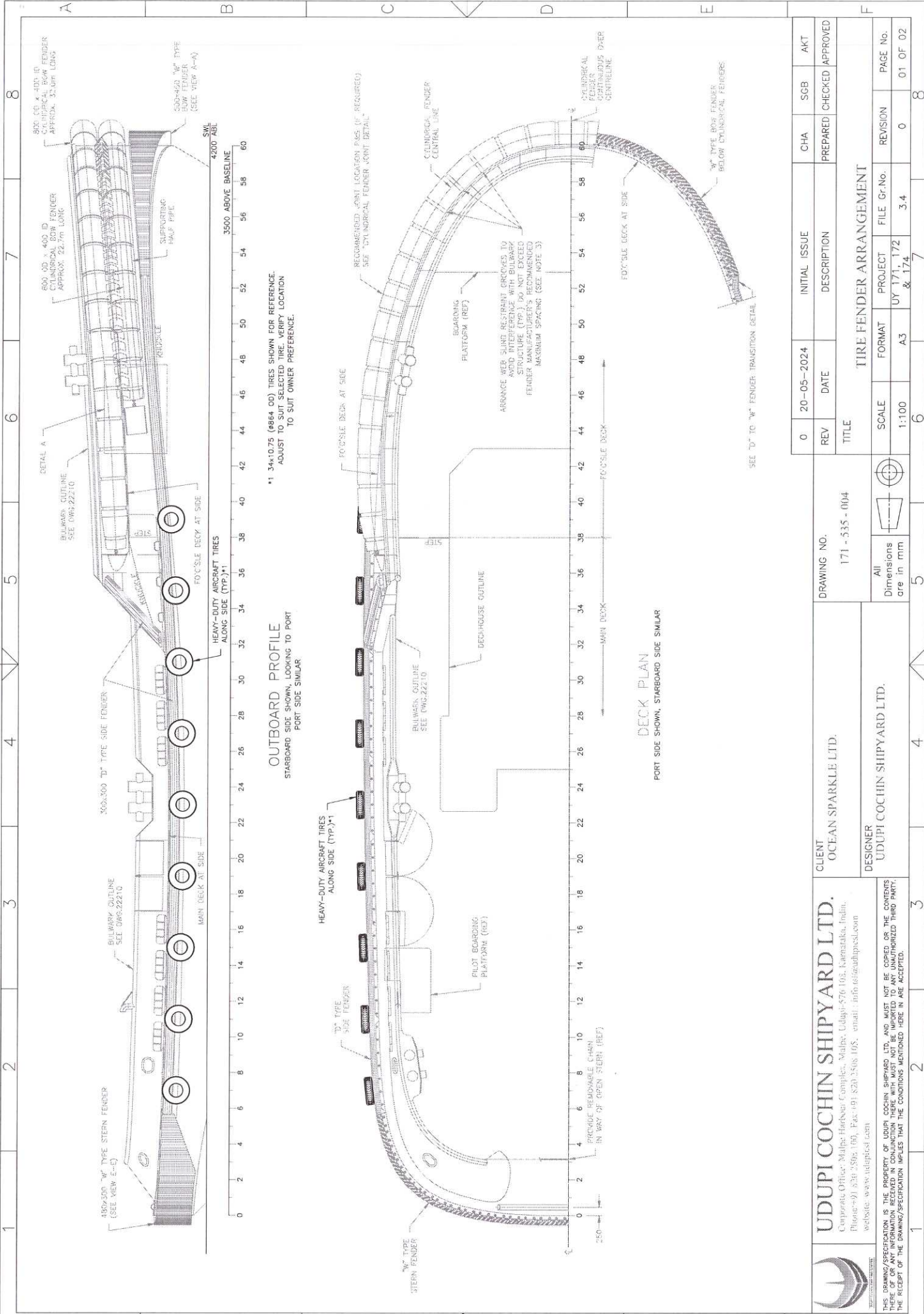

*1 34x10.75 (4864 00) TIRES SHOWN FOR REFERENCE.
ADJUST TO SUIT SELECTED TIRE. VERIFY LOCATION
TO SUIT OWNER PREFERENCE.

OUTBOARD PROFILE
STARBOARD SIDE SHOWN, LOOKING TO PORT
PORT SIDE SIMILAR

DECK PLAN
PORT SIDE SHOWN, STARBOARD SIDE SIMILAR

0	20-05-2024	INITIAL ISSUE	CHA	SCB	AKT
REV	DATE	DESCRIPTION	PREPARED	CHECKED	APPROVED
TITLE					
DRAWING NO.			171 - 535 - 004		
CLIENT			OCEAN SPARKLE LTD.		
DESIGNER			UDUPI COCHIN SHIPYARD LTD.		
SCALE	FORMAT	PROJECT FILE	G.No.	REVISION	PAGE No.
1:100	A3	UY 171, 172 & 174	3.4	0	01 OF 02

UDUPI COCHIN SHIPYARD LTD.
 Corporate Office: Malpa Harbour Complex, Malpa, Udupi-576 103, Karnataka, India.
 Phone: (+91) 830 2586 100, Fax: (+91) 820 2586 105, email: info@udupis.com
 website: www.udupis.com

THIS DRAWING/SPECIFICATION IS THE PROPERTY OF UDUPI COCHIN SHIPYARD LTD. AND MUST NOT BE COPIED OR THE CONTENTS THEREOF REPRODUCED IN ANY MANNER WITHOUT THE WRITTEN PERMISSION OF UDUPI COCHIN SHIPYARD LTD. THE RECEIPT OF THE DRAWING/SPECIFICATION IMPLIES THAT THE CONDITIONS MENTIONED HEREIN ARE ACCEPTED.

UDUPI COCHIN SHIPYARD LTD.

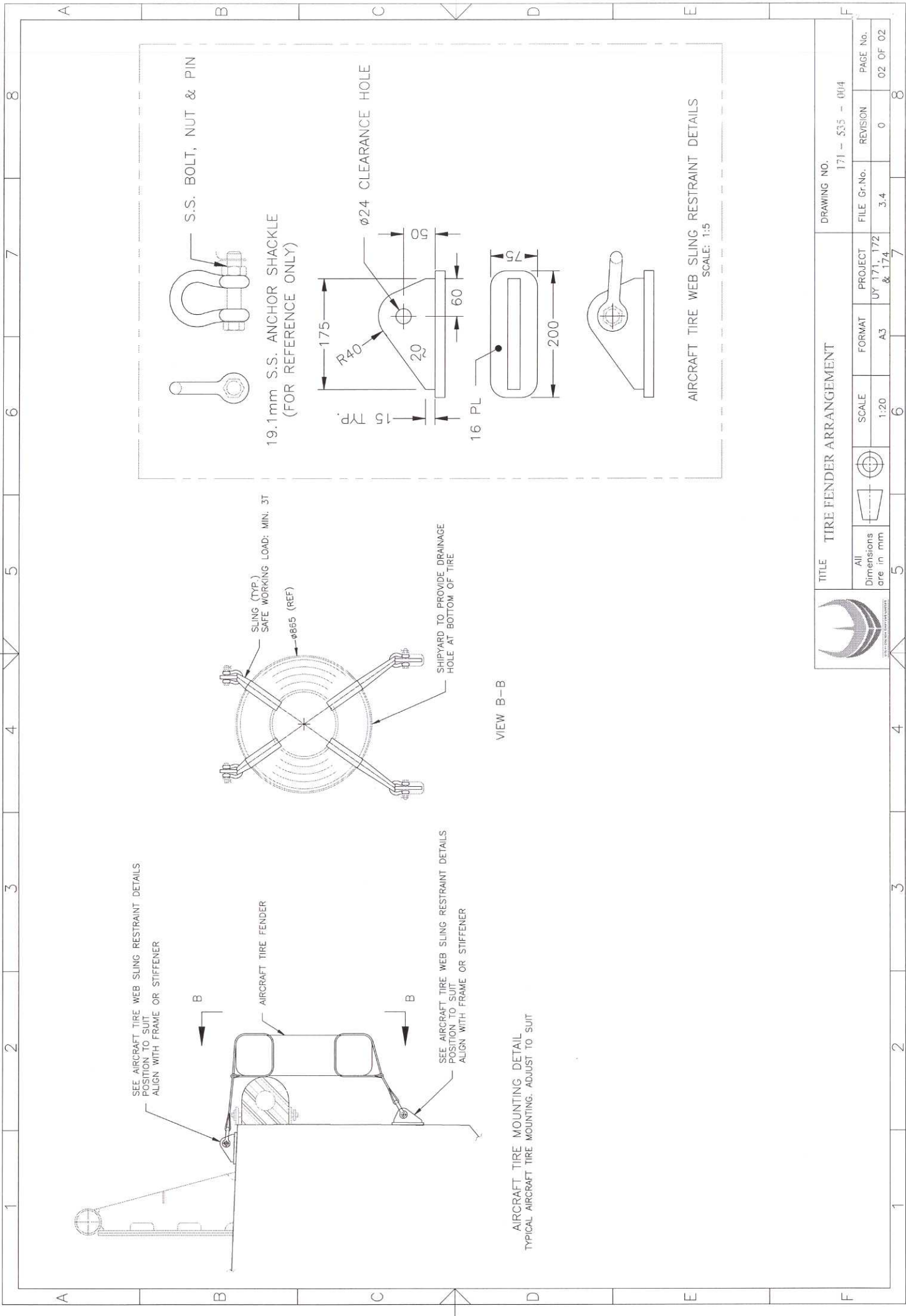

SEE AIRCRAFT TIRE WEB SLING RESTRAINT DETAILS POSITION TO SUIT ALIGN WITH FRAME OR STIFFENER

AIRCRAFT TIRE FENDER

SEE AIRCRAFT TIRE WEB SLING RESTRAINT DETAILS POSITION TO SUIT ALIGN WITH FRAME OR STIFFENER

AIRCRAFT TIRE MOUNTING DETAIL
TYPICAL AIRCRAFT TIRE MOUNTING. ADJUST TO SUIT

VIEW B-B

S.S. BOLT, NUT & PIN

19.1mm S.S. ANCHOR SHACKLE
(FOR REFERENCE ONLY)

Ø24 CLEARANCE HOLE

16 PL

AIRCRAFT TIRE WEB SLING RESTRAINT DETAILS
SCALE: 1:5



TITLE TIRE FENDER ARRANGEMENT

DRAWING NO.
171 - 535 - 004

All Dimensions are in mm	SCALE 1:20	FORMAT A3	PROJECT UY 171, 172 & 174	FILE Gr.No. 3.4	REVISION 0	PAGE No. 02 OF 02
--------------------------	------------	-----------	---------------------------	-----------------	------------	-------------------

SL NO	Description	Compliance by Supplier (YES/NO)
		In case of non-compliance, please provide remarks.
1	Tenderers are to carefully go through the terms and conditions and the technical specification of the items for which offers are called for. Tenderers have to adhere to above and supply full technical scope of items along with compliance of commercial conditions. UCSL have full right upon deviations, if any, including rejecting the partial scope/ complied offers.	
2	Offers are to be furnished in duplicate and should be free from overwriting. Corrections and additions, if any, must be attested. In the case of E-tender offers shall be submitted only through UCSL E-procurement portal. Incomplete/ambiguous/conditional offers are likely to be rejected.	
3	Technical checklist, if applicable and current general terms & conditions of enquiry duly filled and signed and technical specifications of items offered (refer clause 5), should be submitted along with part-1 techno-commercial bid in the case of two bid tenders and along with the bid documents in the case of single bid. Non receipt of the document may lead to rejection of offers. In the case of E-tender filling up of GTC check list in the portal itself is sufficient.	
4	Spare/Tool requirements to be confirmed, if applicable i) Spare parts shall be furnished in accordance with the Class recommendations and manufacturers standard ii) The same shall be included in offered costs and shall be a part of L1 evaluation.	
5	Following Certificates/documents is to be submitted for the item in the event of an order: Refer PTS Clause no 3 conditions of supply (page no 2) Refer PTS Clause no 4 testing and Inspection (page no 2)	
6	SPECIFICATIONS: - a) Manufacturer's name, their trade mark and brand, if any, should invariably be mentioned and illustrative leaflets giving technical particulars (technical details of items offered including technical literature) etc., should be attached to the offer. b) Materials offered shall conform to UCSL specifications and drawings. c) Samples are to be supplied free of cost in the event of requirement by UCSL. The detailed working drawing, if called for, is also to be furnished for approval before commencement of manufacture.	
7	Packing materials should be eco-friendly.	
8	Supplier should follow the statutory requirements of product offered.	
9	Products supplied shall be non-toxic and harmless to health. In case of toxic materials, Materials Safety Data Sheet may be furnished along with the material.	
10	COMMISSIONING & SEATRIALS: - Service engineer assistance for 07 days(excluding travel days, Sundays) irrespective of number of engineers in 1 trips per shipset. Total 42 man-days (excluding travel days, Sundays) irrespective of number of engineers in 6 trips for all 6 ships to be included in scope and cost. b) Cost considered to include all charges incurred for travel, lodging, food and local transport costs. e) Additional man-day rates to be indicated separately (all inclusive of cost for boarding, lodging and local transport etc.) for extension beyond agreed man days. Additional man days/trips only applicable after completion of 42 man-days & 6 trips as indicated in 9a for all the vessels together. d) Whether the applicable taxes in India shall be borne by UCSL/Supplier (In the case of foreign vendors)- e) Income tax liability of non-resident service engineer based on his period of stay in India shall not be borne by UCSL f). The non-resident seller/service provider shall provide such documents that are necessitated by the Indian income tax laws so as to enable UCSL to comply with the provisions of Indian statute and for payments of income tax in India. Following documents shall be sought by UCSL in this regard (i) Certificate under 10 (F) (ii) Tax residency certificate (iii) The certification regarding the existence/non-existence of business connection or permanent establishment in India. (The above is only an indicative list)	
11	Taxes and duties, if any, payable extra are to be indicated in the price part for single bid and in techno-commercial part and price part (in the case of 2 bid tender).	
12	MSEs, Startups and Make in India a) Local Suppliers (Make in India), MSME firms and Startups will be eligible for various Relaxations in pre-qualification criteria and other Benefits as per the orders promulgated by Government of India. Bidders are advised to refer the details of various Benefits and Relaxation in pre-qualification criteria as published at CSL website (www.cochinshipyard.in) under the Tenders-tab for further reference.	
13	Delivery Period: a. Delivery time required for supplies should be indicated in the offer (including time frame for drawing preparation, class approvals, manufacture etc.) Please note, required date at UCSL are as follows: b. The supplier shall submit all the drawings for approval from UCSL within 15 days from the date of PO and UCSL has forward the drawing approval within 15 days thereafter. Material required date at UCSL 1st Shipset- Within 3 month from the date of PO 2nd Shipset- Within 5 month from the date of PO 3rd and 4th Shipset- Within 7 month from the date of PO	
14	SHIPMENT a. Supplier shall intimate UCSL the readiness of the Equipment/ Machinery/ Components and Parts prior to fourteen days of shipment. b. A minimum 14 days free detention period is to be granted for clearance of the goods at Mangalore/Mumbai/Chennai seaport, as applicable for full containers.	
	PAYMENT TERMS:	

SL NO	Description	Compliance by Supplier (YES/NO)
		In case of non-compliance, please provide remarks.
15	a. For equipment's with commissioning	
	UCSL payment term is 80% along with 100% applicable taxes within 30 days from the date of receipt and acceptance of items at UCSL stores after inspection and balance 20% on satisfactory completion of commissioning certified by UCSL.	
	b. For general items	
	UCSL payment term is 100% within 30 days of receipt and acceptance of materials at UCSL stores after inspection.	
16	c) Payment mode shall be Electronic Clearing System (ECS)/cheque /NEFT/ /LC/CAD/TT-as mutually agreed in line with above standard payment terms. Variations from standard terms, if any, shall be appropriately loaded for tender comparison purposes for arriving the lowest bid. Bank charges (including LC charges, if any) inside India will be to UCSL account and outside India to supplier's account (In the case of import shipments). The charges for LC amendment, if any, shall be borne by the parties by whom the same is attributed/ necessitated.	
	d) Normally advance payments are not encouraged. In case, if advance payment is sought, the same can be considered for a maximum of 10% order value only. Interest at the base rate of SBI (applicable on the date of price bid opening) + 1% for the amount of advance will be charged. In addition, Bank guarantee for equivalent amount of advance to cover the period till advance payment is adjusted to be furnished. (i.e till completion of supplies or for a period as specifically agreed + 90 days). In case interest as above is not agreeable to be paid, the same will be loaded on your quoted basic prices, for tender comparison purposes for arriving the lowest bid	
	e) For deviation in Payments terms from UCSL standard terms, if any, aforesaid interest will be loaded on quoted item prices, for tender comparison purposes for arriving lowest bid.	
	f) Part payment shall be considered only if specifically agreed against partial supplies.	
17	Security Deposit/ Warrantee Bank Guarantee:	
	a.i) The successful bidder shall remit a security deposit of 3% of the total order value (excluding taxes, duties) in the form of demand draft drawn in favor of Udupi Cochin Shipyard Ltd towards the satisfactory performance of the contract, if an order is placed on them. Alternatively, a Bank Guarantee equivalent to above % of the total order value (excluding taxes, duties) as per UCSL format from an International Bank as per approved list of banks available in CSL website (for overseas supplier) & Scheduled Indian bank for Indian supplier is to be submitted, if an order is placed towards satisfactory performance of the contract.	
	a.ii) The supplier shall also agree for 3% of total order value (excluding taxes and duties) as Bank guarantee towards the Guarantee clause	
	a.iii) The Bank Guarantee /DD as above should be initially valid till 90 days after completion of supplies in terms of SD and later revaluated (within the validity of initial BG) to cover the guarantee period mutually agreed plus 90 days. However, in the case of items where WBG is not applicable (as in 15.a.ii), the SD shall be valid for item delivery at yard plus 90 days. Fixed Deposit Receipt (for equivalent amount of Security Deposit/WBG required as per tender) in lieu of bank guarantee is also acceptable. Fixed Deposit Receipt shall be in the name of supplier with lien marked in favor of Udupi Cochin Shipyard Limited, Kochi.	
	a.iv) The above SD/WBG is required or applicable only when the total order value (excluding taxes and duties) is Rs.20lakhs and above (or equivalent foreign currency). In case supplier have quoted Rs.20 lakhs and above in tender and indicated that BG as not applicable in the check list, the clause 15b shall be considered for further process.	
	b) If the bidder is not agreeable to submission of SD/ warrantee bank guarantee as per UCSL general terms and conditions of enquiry, UCSL reserves the right to reject the offer at our discretion or 3% of total order value (excluding taxes and duties) will be added to the quoted price for tender comparison/ evaluation purpose on case to case basis for arriving the lowest bid.	
	However, in cases where total quoted value is less than 20 lakhs, (ie split order etc) and the order value of entire tendered items is more than Rs 20.0 lakhs, the aforesaid loading will be applied on individual items in following cases.	
_____ The bidder has not quoted for entire tendered quantity		
_____ UCSL has technically / commercially rejected a few items in the tender		
	c) SD to be submitted within 2 weeks of receipt of order from yard.	
	d) Format of bank guarantee along with enquiry to be agreed, in general	
	e) Mode of receipt of bank guarantee is strictly through SWIFT mode from supplier bank to UCSL designated bank (for overseas bidders)	
18	Risk Purchase: If the supplier fails to supply the items ordered in good quality as per contract specification and fails to deliver within the delivery date or violate any of the terms and conditions of the purchase order, UCSL shall have the following rights.	
	a. To cancel the order partially or fully with 15 days, notice and to forfeit the security deposit, if any.	
	b. To impose tender holiday for the vendor for an appropriate period as decided by UCSL	
	c. To initiate alternate procurement action at the risk and cost of the supplier. This Risk Purchase clause is applicable only in the case of total order/ contract value (excluding taxes and duties) is Rs.20 lakhs and above (or equivalent foreign currency). Cases of value less than 20 lakhs will be addressed by serving appropriate caution/ warning notice to the firm.	
19	Liquidated Damage:	
	In case of delay in supply of ordered materials beyond the stipulated delivery period, which is not attributable to UCSL, supplier is to pay Liquidated Damages (and not by way of penalty) a sum equivalent to ½% (half percent) per week or part of the week of the total basic price in case of Machinery/Equipment and of basic price of materials delayed in all other cases, subject to a maximum of 10% of the total basic price of undelivered material/10% of total basic price of machinery/equipment (Total basic price is the order value excluding freight, taxes, other charges etc.). Further, GST will be applicable upon LD and the same also will be deducted along with LD. However,LD applicability is without prejudice to UCSL right to terminate contract for delayed delivery or other actions as per clause 16.	
	Guarantee	

SL NO	Description	Compliance by Supplier (YES/NO)
		In case of non-compliance, please provide remarks.
20	a) The Items supplied shall be guaranteed for rated performance and against damage or failure due to faulty design, defective materials and bad workmanship for a period of 18 months from the date of delivery of the ship to Owners OR 30 months from the date of delivery of items to Yard, whichever is earlier. Should such damage/failure occurred within the Guarantee period, the Supplier should immediately rectify the failure by repair/replacement of any such part found to be under performing/ defective, at his own expenses.	
	b) Further to equipment guarantee, replaced/repared items shall be guaranteed for 12 months from date of repair/replacement.	
	c) Design life for Hull protection anode system shall be for 5 Years.	
21	Preservation & Packing 1.The preservation and packaging of the equipment to ensure that there is no damage and deterioration during transit and the period when the item is in storage in storhouse. 2. Duration of validity of preservation to be indicated. 3. Methodology for receipt inspection without affecting preservation (for main equipment and loose supplied items) is to be indicated by the OEM including any requirement for re-preservation 4. The procedure for re-preservation to be supplied by the firm. 5. Requirement of special provisions for storage and transportation to be specifically indicated. 6. Any consumables required for preservation/ re-preservation beyond a stipulated time period to be clearly indicated by OEM.	
22	Jurisdiction: All questions, disputes or difference arising under, out of, or in connection with contracts shall be subject to the exclusive jurisdiction of the Courts at Bangalore, India. Alternate dispute resolution mechanism can also be considered.	
23	Force Majeure condition: Should failure in performance of the contract or part thereof arise from war insurrection, restraint imposed by Government, Act of Legislature or other Statutory Authority or illegal strike, riot, legal lock-out, flood, fire, explosion, act of God or any inevitable or unforeseen event beyond human control which may be construed as reasonable ground for an extension of time, UCSL may allow such additional time as is mutually agreed, to be justified by the circumstances of the case. The occurrence/cessation of force majeure situation is to be informed with documentary evidence within 15 days from the date of occurrence/ cessation.	
24	Indian Agent: a) Udupi Cochin Shipyard Ltd prefers to deal directly with the supplier. However, if the supplier appoints an Indian Agent to deal with Udupi Cochin Shipyard Ltd., the Agency commission payable by the supplier to such an agency shall be intimated.	
	b) If manufacturers affect the supply through Agents only, authorization in writing from manufacturers in favor of the Agent for supply to UCSL shall be furnished.	
	c) In case where an Agent participates a tender on behalf of a Foreign manufacturer Indian agent should submit specific authorization from the authorized person of foreign manufacturer.	
	d) In a tender, either the Indian agent on behalf of the Principal/ OEM or Principal/OEM itself can bid but both cannot bid simultaneously for the same item/ product in the same tender. If an agent submits bid on behalf of principal/OEM, the same agent shall not submit a bid on behalf of another principal/OEM in the same tender for the same item/product. Indian agents cannot represent more than one firm or quote on their behalf for any particular tender.	
	e) Clarifications, either technical or commercial, should be submitted to points specially asked for only. The opportunity so given should not be used for correcting/changing/amending the data/conditions already submitted with the tender	
25	PRICING: a. Overseas firms should quote prices both on FOB and C&F Chennai Seaport terms. Indigenous bidders should quote prices for delivery of materials at UCSL stores. Insurance shall be to UCSL scope. In the case of E tender C&F price shall be quoted and the freight charges shall be indicated separately under header conditions as per the provision in the CSL e-tender portal.	
	b. Exchange rate variation will not be applicable and the prices shall be fixed for an order within validity period in the case of indigenous/ import orders.	
	c. Offer to be submitted in INR currency Generally. Indian Firms shall quote in INR only.	
	d. Comparison of prices will be in INR only. All foreign currencies will be converted to INR for comparison and Exchange rate as on date of price bid opening shall be considered for arriving lowest bid	
	e. Prices should be valid for acceptance for a period of four months from the date of tender opening.	
	f. No enhancement of rate for whatsoever cause will be allowed once the offer is accepted and an order is placed. Withdrawal of the quotation after it is accepted or failure to make the supply within the stipulated delivery period, will entail cancellation of the order and forfeiture of Earnest Money Deposit/Security deposit, if any and/or risk purchase, without prejudice to other penal actions, including tender holiday after serving show cause notices, as deemed fit.	
	g. Conditional discounts, if any, will not be reckoned for tender evaluation/ comparison purpose. However, if the bidder becomes L1 at original offer, conditional discount shall also be considered.	
	h. Unpriced bid (price bid without price) duly signed is to be submitted along with techno-commercial offer in the price format, provided. Price should be quoted separately for each item shown in the format. In the event price bid is different from the unpriced format already submitted, yard reserves the right to reject the offer at our discretion without any further discussions. Details of optional items, if any, should be indicated under separate heading in the Techno commercial bid and the respective price details should also be given in the price bid. Combining of figures against more than one item and ambiguous clauses will lead to rejection of the bid.	

SL NO	Description	Compliance by Supplier (YES/NO)
		In case of non-compliance, please provide remarks.
	<p>i. If, in the price structure quoted for the required material/ item, there is discrepancy between the unit price and the total price (which is obtained by multiplying the unit price by the quantity), the unit price shall prevail and the total price corrected accordingly. If there is an error in a total corresponding to the addition or subtraction of subtotals, the subtotals shall prevail and the total shall be corrected. If there is a discrepancy between words and figures, amount in words of respective figures shall prevail. If the bidder does not agree to the observation of the UCSSL, the tender is liable to be rejected and the same shall be intimated.</p> <p>j. After submission of quotation/price offer no unsolicited correspondence will be entertained.</p> <p>k. Udupi Cochin Shipyard Limited does not bind itself to accept the lowest or any tender but reserves to itself the right to reject any or all or a part of any tender at its discretion.</p> <p>l. UCSSL reserves the right to place order to the techno-commercially qualified lowest bidder in full or individual items to the respective lowest bidders in the tender (except in cases where basis of L1 arrival is declared specifically in enquiry). Also please refer loading applicable for split order of value less than 20 lakhs (Clause 15 b)</p> <p>m. In the case of part quantity order, the quoted freight charges applicable for the entire quantity as per enquiry shall be apportioned and allocated.</p> <p>L1 computation shall be based on total cost of all line items, including cost of spares as per tender & Class/certification charges, if any required (excluding GST/IGST). For all import consignments directly imported in UCSSL's name/or on High Seas Sale agreement, customs duty is not applicable at import clearance. Customs clearance at Chennai port and transport till UCSSL stores shall be to UCSSL account.</p>	
26	<p>Integrity Pact: As per Government of India (Central Vigilance Department), UCSSL and the SUPPLIER have to sign an Integrity Pact for the high value contracts, for ensuring transparency, equity and competitiveness in public procurement. The Tenderer has to sign Pre-Contract Integrity Pact as per format enclosed and to submit along with your offer. The above is applicable when the total basic price is above Rs. 100.0 lakhs. (present limit)</p>	
27	<p>Grievance Redressal Committee: As an alternate dispute redressal or reconciliation mechanism (other than arbitration clause), Cochin Shipyard has constituted Grievance Redressal Committee. Currently following executives of the committee may be contacted for the settlement of disputes, if any, arising out of all contracts.</p> <p>a) Mrs. Anjana KR, GM (Design) b) Mr.Subramanian K K, Deputy General Manager (HR) c) Mr. Shibu John, Deputy General Manager (Finance)</p>	
28	<p>SUB CONTRACTING AND ASSIGNMENT Supplier shall not contract with any subcontractor and/or vendor without the prior written consent of UCSSL. Such consent shall not relieve the Supplier from any of his responsibilities and liabilities under the Purchase Order. In addition, Supplier shall ensure that the terms and conditions of any such contract shall comply with and correspond to the terms and conditions of the Purchase Order.</p>	
29	<p>General: a. Prior to price bid opening, UCSSL is at liberty to take the credit rating of bidders at our cost on case to case basis, and to include the same during the evaluation of the tender. b. Deviations, if any in the techno-commercial offer from that of the tender enquiry in any form should be clearly furnished in a separate document titled as "List of Deviations", failing which it will be presumed that all the terms and conditions are acceptable. c. The techno-commercial part alone will be opened initially on the due date of tender. The price part will be opened only after evaluation of the Techno commercial part. Date of opening of the price part will be intimated to those firms whose Techno- commercial bids would be acceptable after the evaluation. Suppliers are allowed to depute their authorized representative to be present at the time of opening of Price Bid of their tender only. In case of E-Tender, suppliers shall not depute their representative to CSL. However techno-commercially qualified supplier can view the price details in CSL E-procurement portal after opening the price bid</p>	
30	<p>P.O:- a. In the event supplier's offer leads to an agreement to effect supplies, a formal purchase order shall be issued by UCSSL on the basis of agreed terms and conditions of tender. b. Upon placement of order (by post or mail) the supplier shall submit the acknowledgement (ie: signed and stamped original/ scanned soft copy by mail) as a token of acceptance of order within 5 days. In case UCSSL doesn't receive the above, it will be deemed as accepted. c. Supplier shall submit monthly progress report on the ordering status of raw materials, construction progress of the items ordered by UCSSL, supporting with photo evidence.</p>	
31	<p>SUPPLY: - a) UCSSL reserve the right to inspect the goods after receipt at UCSSL store / prior to dispatch (by UCSSL or UCSSL authorized agency at yard cost). Short supply / Mismatch / Replacement of Defective items / those not meeting agreed / contractual specification/ Items failing during commissioning shall be sent on air freight/ DDP basis courier freight prepaid/delivered at UCSSL store. The customs clearance charges of above shall be to supplier account. b) Replacements during guarantee period to be sent on Duty and all taxes paid basis to location as required by yard/vessel owner with all expenses to supplier account. c) Defective items, if any, after receipt shall be sent back on cost, carriage, handling and insurance prepaid basis including re-export (wherever desired by supplier) to be arranged by supplier. Defective items shall be returned after receipt of replacement item. Supplier shall replace all/ part of items as applicable, in case of rejection, within 4 weeks of reporting the defect, without any additional cost to UCSSL. In case the defective materials are not taken back within the said period, UCSSL reserves the right to dispose the same without further intimation.</p>	

SL NO	Description	Compliance by Supplier (YES/NO)
		In case of non-compliance, please provide remarks.
	d) The supplier shall compensate UCSL for loss on account of shortage in quantity and number of pieces received than that indicated in the bill of lading provided the UCSL's claim is rejected by the insurance due to any fault of supplier. Such claims, if any, shall be supported by recognized surveyors report. The supplier shall also compensate for losses, if any sustained by the UCSL due to defective packing and/or marking of the goods not in accordance with the terms of contract. The time limits for filing claims under clauses above shall be generally 180 days from the date of complete discharge of goods.	
32	UCSL reserves the right to alter, modify the scope of supply at its discretion and in consistent with the policy of the Government of India and statutory bodies under them as applicable to the contract from time to time.	
33	UCSL shall, at its own discretion and costs opt for obtaining credit information report on supplier's financial credentials through credit rating firms. The same shall also be considered as criteria for commercial evaluation. In the event supplier's credit rating is not at least satisfactory, offer will be summarily rejected.	
34	Public procurement policy as per order No. D.O. No. P-45021/2/2017-PP (BE-II) (E-1588) by Department for promotion of Industry and Internal Trade Ministry of Commerce & Industry is applicable for this tender	
35	UCSL reserves the right to commercially reject the offer if compliance is not issued to terms at Sl. No.14, 15, 16, 17 & 18 without any further clarification / notice / communication in this regard from M/s. Udupi Cochin Shipyard Ltd., even though the offer is technically acceptable.	
36	UCSL has an option of receiving 4 + 4 more similar projects within June 2024 and upon exercise of this option by owner yard will confirm the same quantity of item to supplier within June 2024 or earlier. Therefore the price offer shall consist the prices for current projects as well as the discounted prices applicable for these optional projects with validity to confirm the order till June 2024. However the L1 determination shall be purely based on current confirmed quantity.	
37	Restriction of bidders sharing land border with India vide Office memorandum dt 23.7.2020 Order - Public Procurement no 1 dt 23.7.2020, Order no 2 dt 23.7.2020 and Order no 3 dt 24.7.2020	
A	Requirement of registration	
1	Any bidder from a country which shares a land border with India will be eligible to bid in this tender only if the bidder is registered with competent authority as per C below. In works contracts, including turkey contracts, contractors shall not be allowed to sub contract works to any contractor from a country which shares a land border with India unless such contractor is registered with Competent authority. Relevant certificate to be submitted by bidder from a country which shares land border with India except for bidders to which Govt of India has extended lines of Credit or in which Govt of India has development projects, along with the offer as proof of registration with competent authority, failing which the offer will not be considered. A certificate is to be submitted by the bidder for compliance with the order referred above along with tender documents for consideration of offer (Wordings are as per Clause below). If such certificate given by a bidder whose bid is accepted is found to be false, this would be a ground for immediate termination and further legal action in accordance with law.	
2	Wordings of certificate to be submitted along with tender documents for Works involving possibility of sub contracting	
3	I have read the clause regarding restrictions on procurement from a bidder of a country which shares a land border with India and on sub contracting to contractors from such countries. I certify that this bidder is not from such a country or if from such a country has been registered with the competent authority and will not subcontract any work to a contractor from such countries unless such contractor is registered with the competent authority. I hereby certify that this bidder fulfils all requirements in this regard and is eligible to be considered(Evidence of valid registration by the competent authority shall be attached wherever applicable)	
B	Validity of registration	
1	Registration should be valid at the time of submission of bids and at the time of acceptance of bids. In respect of supply otherwise than by tender, registration should be valid at the time of placement of order. If the bidder is validly registered at the time of acceptance /order placement, registration shall not be a relevant consideration during contract execution.	
C	Competent authority and Procedure for registration	
1	The competent authority for the purpose of registration under the order shall be Registration committee constituted by the Department of Promotion of Industry and Internal Trade (DPIIT). Details of the committee and procedure for registration and restrictions shall be as per Ann I of the Order - Public Procurement no 1 dt 23.7.2020 issued by Ministry of Finance, department of Expenditure.	
D	Definition of Bidder and Bidder from a country sharing land border with India	
1	Bidder is defined as any person or firm or company including any, member of a consortium or joint venture, every artificial, juridical person not falling in any of the descriptions of bidders stated hereinbefore, including any agency, branch or office controlled by such person, participating in a procurement process.	
2	"Bidder from a country which shares a land border with India" for the purpose of this Order means:- a) An entity incorporated, established or registered in such a country; or b) A subsidiary of an entity incorporated, established or registered in such a country; or c) An entity substantially controlled through entities incorporated, established or registered in such a country; or d) An entity whose beneficial owner is situated in such a country; or e) An Indian (or other) agent of such an entity; or f) A natural person who is a citizen of such a country; or g) A constitution or joint venture where any member of the consortium or joint venture falls under any of the above.	
3	Type of business entity (Private Limited Company/ Public Limited Company/ Sole Proprietorship/ One Person Company/ Partnership/ Limited Liability Partnership/ Joint Venture/ Trust/ NGO) In case of incorporated entity - to attach certificate of incorporation	
4	Beneficial Owners - as defined in the Department of Expenditure Order (Public Procurement No.1) issued vide No. F.No.6/18/2019-PPD dated 23rd July, 2020.	

SL NO	Description	Compliance by Supplier (YES/NO)
		In case of non-compliance, please provide remarks.
	Details of all beneficial owners having entitlement of more than 01% of shares or capital or profit to be given, in the format as given in Annexure-I duly certified by practicing Chartered Account in India.	
	Preference to Make in India	
	Purchase preference in accordance with Public procurement (Preference to Make in India Order - 2017) Order from Department of Promotion of Industry and Internal Trade P - 45021 /2/2017/- B.E -II dt ,4.6.2020 and as amended from time to time shall be applicable as per below	
38	In the procurement of all goods/services/works in respect of which there is sufficient local capacity/local competition, only Class I Local suppliers shall be eligible to bid irrespective of purchase value	
	In the procurement of all goods/services /works which are not covered as above and with estimated value of purchase less than Rs 200.0 Crores, only Class I local suppliers along with Class II local suppliers shall be eligible to bid.	
39	Purchase preferences for Class I local suppliers	
A	In the procurement of goods/works covered under 2 above and which are divisible in nature, Class I local supplier shall be eligible for Purchase preference over Class II/Non local supplier as per following	
B	If L1 bid is not a Class I local supplier, 50% of the order quantity shall be awarded to L1. Thereafter the lowest bidder among Class I local supplier will be invited to match the L1 price for the remaining 50% quantity subject to Class I local supplier quoted price falling within 20% margin. Contract for that quantity shall be awarded to such Class I local supplier subject to matching L1 price. In case such lowest eligible Class I local supplier fails to match L1 price or accept less than offered quantity, next higher Class I local supplier within 20% margin shall be invited to match the L1 price for the remaining qty and so on. If some quantity is left uncovered on Class I local supplier, such balance quantity shall be ordered on L1 bidder.	
C	For procurements that are not divisible in nature and in procurement of services evaluated on price alone, Class I local supplier shall get purchase preference over Class II/Non local supplier as per below	
D	If L1 is not a Class I local supplier, lowest bidder among Class I local supplier will be invited to match L1 price subject to Class I local supplier quoted price falling within 20% of L1 price and contract will be awarded to such Class I local supplier, subject to matching L1 price. In case such lowest eligible Class I local supplier fails to match L1 price, procedure same as para 3 above will be opted. In case none of Class I local suppliers within 20% margin matches L1 price, contract shall be awarded to L1 bidder. The purchase preference as above will be only for Class I local supplier and Class II local supplier will not be eligible for any Purchase preference	
E	Local content requirement to categorize a supplier as Class I/Class II/Non local supplier shall be as per below. Definition of local content shall be as per order dt 4.6.2020 ie amount of value added in India which shall be the total value of the item procured (excluding net domestic indirect taxes) minus the value of import content in the item (including all customs duties) as a proportion of total value in percentage.	
F	Class I -Local content equal to or greater than 50%	
G	Class II-Local content greater than 20%, less than 50%	
H	Non local -Local content less than 20%	
40	Declaration of local content	
A	Class I local supplier /Class II local supplier at the time of tender shall indicate % of local content and provide self-certification that offered item shall meet the local content requirement for Class I/Class II as applicable including details of locations at which local value addition is made.	
B	In case of procurement for a value in excess of Rs 10.0 Crores Class I/Class II local supplier is to provide a certificate from statutory auditor/cost auditor (for companies) /practicing cost accountant/Chartered accountant (suppliers other than companies) indicating % of local content	
C	Verification of the Certificates issued by the bidder shall be carried out by CSL on random basis. False declarations will attract actions as stipulated in the order referred, including other actions as permissible by law.	
D	Exemption is applicable from provisions of order for purchases with estimated values less than Rs 5.0 lakhs	
E	Notwithstanding above, exemptions for meeting local content as per relevant Clause of order dt 4.6.2020 and as amended from time to time shall apply.	

Note: Statement striked out is not applicable.

BANK GUARANTEE IN LIEU OF SECURITY DEPOSIT/
WARRANTY GUARANTEE

To

UDUPI COCHIN SHIPYARD LTD

(Formerly Tebma Shiyards Limited

MALPE HARBOUR COMPLEX, MALPE, UDUPI - 576108.

WHEREAS (Name & Address of Supplier) (Hereinafter called "**the Supplier**") has undertaken, in pursuance of Contract..... No..... Dated: to execute (Name of Contract and brief description of works) (Hereinafter called "**the Contract**").

AND WHEREAS it has been stipulated by UDUPI COCHIN SHIPYARD LTD (The Buyer - hereinafter called "**UCSL**") in the said contract that the Supplier shall furnish CSL with a Bank Guarantee for the sum specified therein as security for compliance with the Supplier's obligations in accordance with the Contract.

AND WHEREAS we have agreed to give the Supplier such a Bank Guarantee.

NOW THEREFORE we (Name of the Bank) having its Head Office at (Address of Head Office) and acting through its branch office at (Address of the executing branch) (Hereinafter called "the Bank") hereby affirm that we are the Guarantor and responsible to CSL, on behalf of the Supplier up to a total of (amount of Guarantee)in words).

We, the bank, hereby irrevocably undertake to pay you any amount not exceeding in total the Guarantee Amount upon receipt by us of your demand in writing accompanied by the following documents:

1. Your signed statement certifying that the Supplier is in breach of his obligation(s) under the Contract and the respect in which the Supplier is in breach.
2. Your signed statement certifying that the Supplier has been given a prior written notice by email from you to make good the aforesaid breach and that the Supplier still failed to fulfill the Contract within 30 days of such notice. A copy of such notice given by email to the Supplier shall be attached to the demand for payment.

Any demand for payment should contain your authorized signatures which must be authorized by your bankers or by a notary public.

We, the Bank, further agree that no change or addition to or other modification of the terms of the Contract or of the Works to be performed there under or of any of the Contract documents which may be made between UCSL and the Supplier shall in any way release us

from any liability under this guarantee, and we hereby waive notice of any such change, addition or modification. We, the Bank, further agree that any change in the constitution of the said contractor or the said bank shall not discharge our liability hereunder.

Notwithstanding anything contained herein:

1. Our liability under this Bank Guarantee shall not exceed
(..... only).

2. This Bank Guarantee shall be valid up to (date) and

3. We are liable to pay the guaranteed amount or any part thereof under this bank guarantee only and only if UCSL serve upon us a written claim or demand on or before(validity date) .

Any demand for payment under this guarantee must be received by us at this office during working hours on or before the validity date. Should we receive no claim from you by the validity date, our liability to you will cease and the guarantee will definitely become null and void whether returned to us or not.

Yours truly,

Signature and seal of the

Guarantor:.....

Name of Bank:.....

Address:

Date:

* An amount shall be inserted by the Guarantor, representing the percentage of the Contract Price specified in the Contract and denominated in respective Dollars / Indian Rupees/Other Currency.